

KALEIDOS INSTALLATION GUIDE

We remind that the combination between 2WIN mobile binocular refractometer and KALEIDOS is called 2WIN-S.

Safety Precaution

- Handle with care.
- Do not remove 2WIN from the KALEIDOS during the assembly
- **The KALEIDOS is counterbalanced in order to stand up when 2WIN is inserted. Please extract 2WIN with caution because this action will change the weight balance inside KALEIDOS. If you don't hold the Kaleidos during this operation it may fall to the ground and you may break the device.**
- Do not use KALEIDOS under humid or dusty environment. Doing so may result in electric shocks.
- Do not place the KALEIDOS on unstable or inclined surface. The KALEIDOS may fall or topple over and cause a damage or injury.
- Do not use the KALEIDOS with a different power supply.
- Do not use KALEIDOS if the user interface mask is not properly installed to avoid wrong measurement.
- Open carefully the back of the KALEIDOS in order to avoid any damage to the plastics
- Manage with care the 2WIN lock



The KALEIDOS is counterbalanced in order to stand up when 2WIN is inserted. Please extract 2WIN with caution because this action will change the weight balance inside KALEIDOS. If you don't hold the KALEIDOS during this operation it may fall to the ground and you may break the device! Damage due to carelessness is out of warranty.

Note on maintenance

- Avoid dust into the Kaleidos

Responsabilities

- Damage due to carelessness is out of warranty.

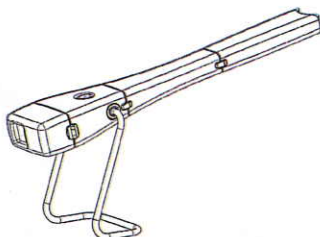

Designed and manufactured by:
Adaptica Srl - Via San Marco 9/H, 35129 - Padova (Italy)
ph. +39 049 773 968 fax +39 049 0970901

KALEIDOS INSTALLATION GUIDE

Packing list

The box contains (default configuration):

- the electronic version of the operating manual (inside the microSD)
- the 2WIN device inside KALEIDOS
- two rechargeable batteries (one already inside the 2WIN)
- a microSD memory card with SD Adapter
- a USB cable (microUSB to USB-A)
- an external battery charger to charge the battery outside 2WIN
- an occluder (infrared patient's eye occlusion system)
- KALEIDOS Power Supply/Charging Adapter
- EU/US AC wall adapter
- Top, middle, bottom of the KALEIDOS pieces (part A, part B, part C respectively)
- base-support (part D)

Installation steps

- 1 - Connect the base-support (part D) with the bottom piece of the KALEIDOS (part A)

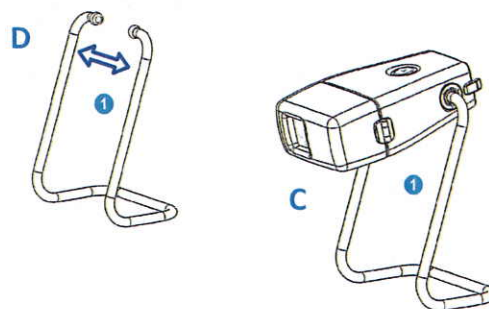

- 2 - Assemble and match the three sections of the tube of KALEIDOS (part A, part B, part C)

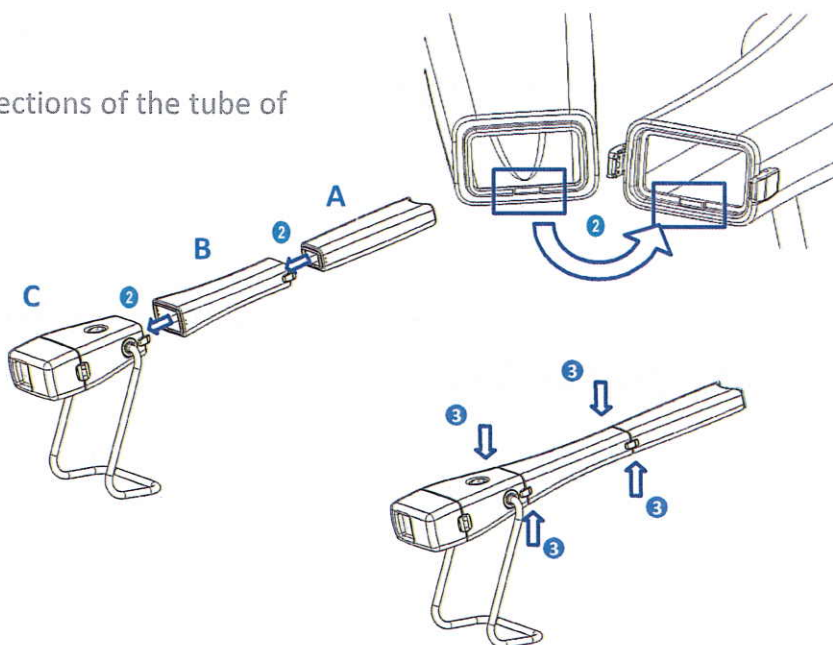

- 3 - Close the clamps on each side

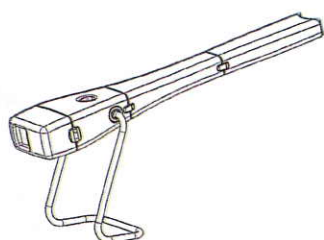

Designed and manufactured by:
Adaptica Srl - Via San Marco 9/H, 35129 - Padova (Italy)
 ph. +39 049 773 968 fax +39 049 0970901

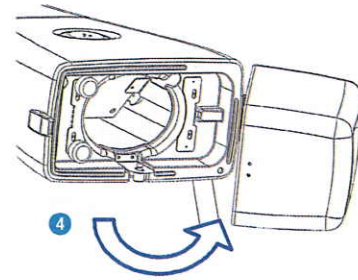

- 4 - Open the back of the KALEIDOS

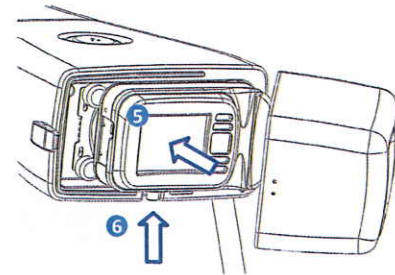

- 5 - Insert the 2WIN in the device compartment

- 6 - Fix the 2WIN by the underside lock

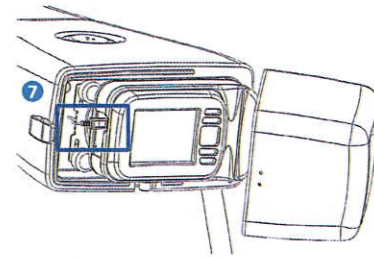

- 7 - Plug the USB connector at the USB connector in the left side of the device

- 8 1) First time use : configure the wireless network connections
(see Wireless configuration setup pag.5)
2) Close the back of the KALEIDOS

- 9 - Short press the power button to switch on the system.
Please refer to pag. 10 "Control Pannel functionalities" section for more advanced features.



- 10 - Apply the furnished mask to the KALEIDOS (follow the "Step by Step guide for biocompatibility mask")

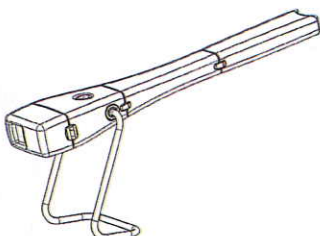
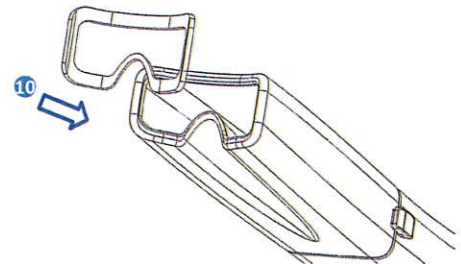

- 11** - Download and install **2WIN** tablet application on your device from

www.adaptica.com/2WINSLASTUPDATE/app.php

Run tablet application, configure your connection with the 2WIN and make your measurement

To switch off the system:

1. Hold for 2s the power button.



2. A longer press will force power - OFF

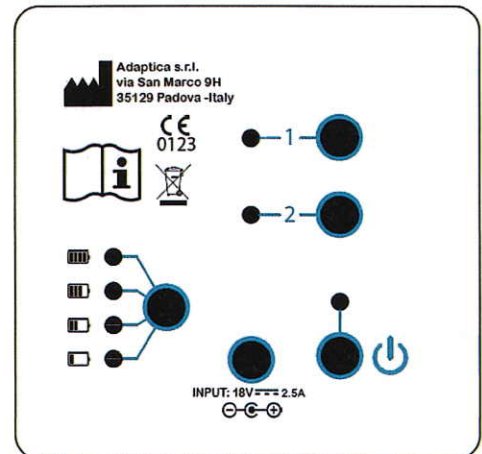

To clean the system:

Wipe the area of the device in contact with the patient with a clean and slightly damp microfiber cloth alcohol-soaked (a towelette is acceptable).

To charge the system:

1. Connect the provided power supply cable to the INPUT 18V – 2.5A.
2. Connect the other end of the power supply to the line.

INPUT: 18V ~ 2.5A

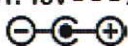

In order to monitor the battery charge press the battery charge button.

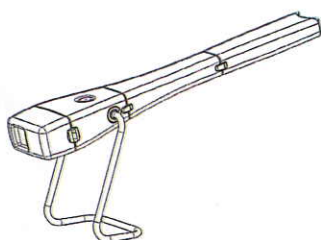
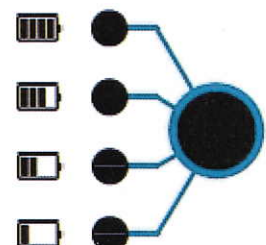

Designed and manufactured by:
Adaptica Srl - Via San Marco 9/H, 35129 - Padova (Italy)
 ph. +39 049 773 968 fax +39 049 0970901

HOW TO TURN WIRELESS CONNECTIVITY IN THE 2WIN

In order to enable the wireless (WiFi) connectivity in the 2WIN and enter in the 2WIN-tablet mode is necessary to follow the following steps:

To enable wireless in the 2WIN

1. Click on "Wireless ON" from
Menu > Settings > Wireless > Wireless ON
You will see the item Wifi Activation and a tick will be displayed next to the label Wireless ON.
2. Select the item "Wifi Config" and push the cross button to find the networks available.
3. Select your favourite Wifi network, then push the cross button to make appear the network password insertion window.
 - Insert the Password of the network;
 - select and push the button "Done";
 - select and push the button "Connect".

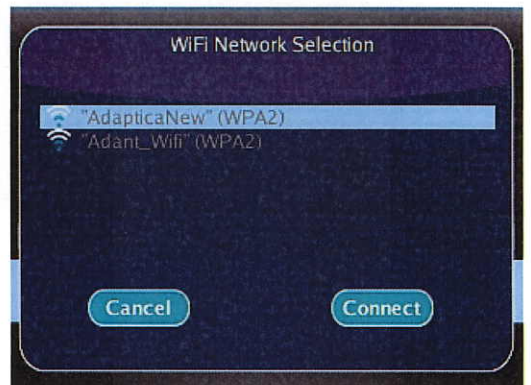
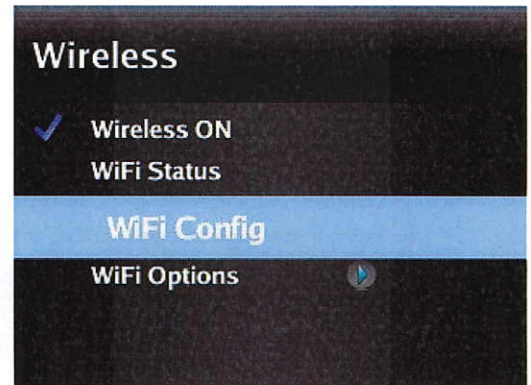

To enable in the 2WIN the Remote Control from a tablet

4.a AUTOMATIC PAIRING:

Long press for 4s of button 2 in the back of the KALEIDOS. The 2WIN enters in pairing mode, so pairing with the application may take place.

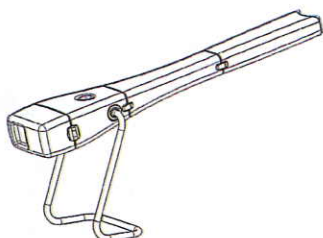
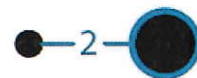

Designed and manufactured by:
Adaptica Srl - Via San Marco 9/H, 35129 - Padova (Italy)
ph. +39 049 773 968 fax +39 049 0970901

4.b MANUAL PAIRING (This section is not required)

- Click on "Kaleidos" from

Menu > Settings > Kaleidos

You will see the item activation and a tick will be displayed next to the label Kaleidos

- Click on "Remote App Connection" from

Menu > Settings > Wireless > Connections

You will see the item App Connections and Remote Control Connection message will appear. Leave that message on your screen and follow the next steps.

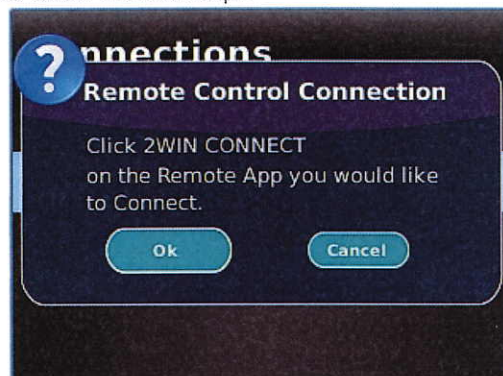
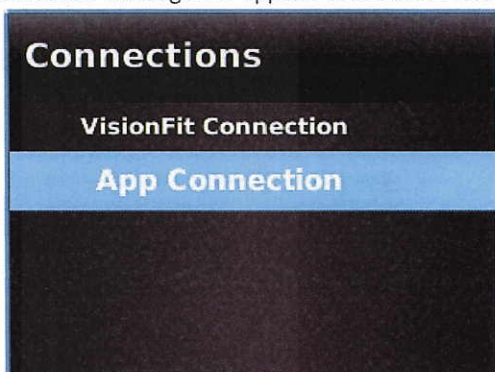
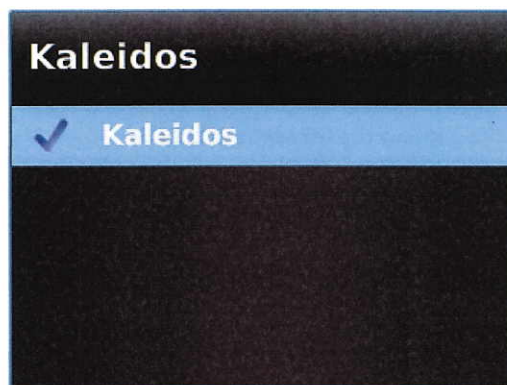

In the 2WIN App:

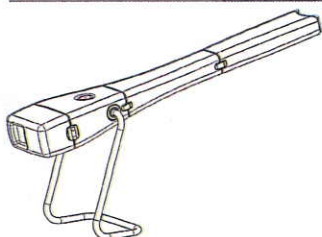
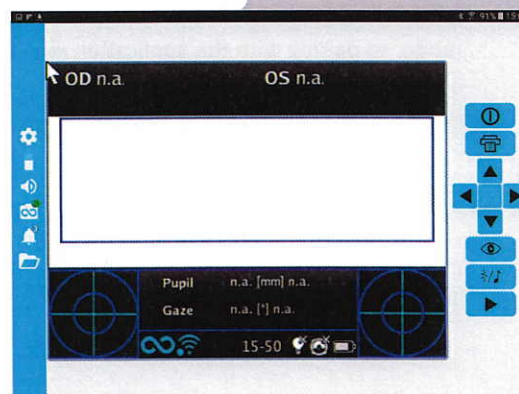
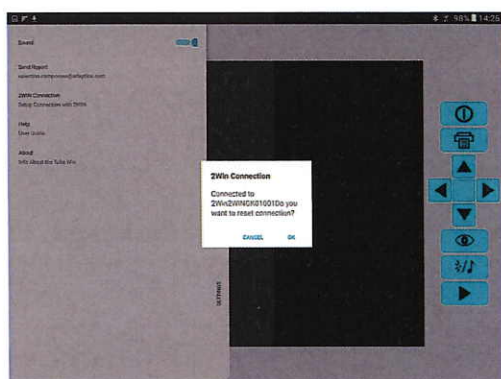
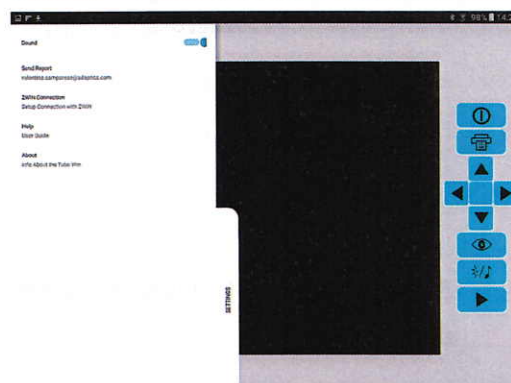

5. Connect the Android device to the same WiFi Network of the 2WIN
6. Click on "2WIN Connection" from Settings Panel a '2WIN Connection' request will be displayed
7. Select and tap the item "OK" to pair the tablet with 2WIN available.

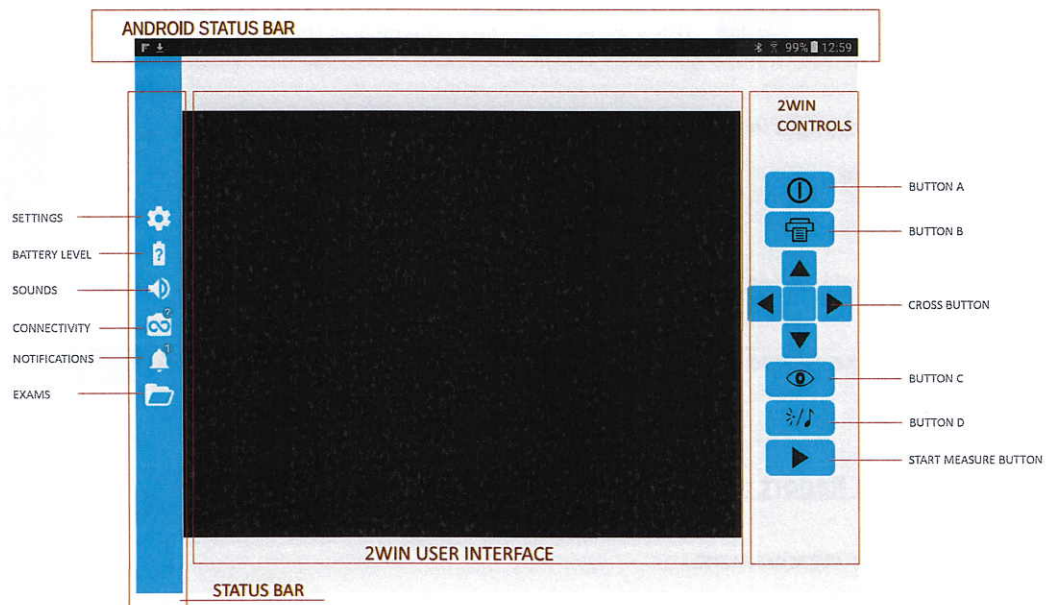

Designed and manufactured by:
Adaptica Srl - Via San Marco 9/H, 35129 - Padova (Italy)
 ph. +39 049 773 968 fax +39 049 0970901

2WIN TABLET APP USER INTERFACE



- The displayed buttons in the app have the same behaviour of the 2WIN buttons. In addition you can find another button on the right side  which stands for the Start button which you can find in the front of the 2WIN.
- To make the measurement, you ask your patient to position his face inside the tube, looking at a group of very dim points, coming from the group of small apertures in the mask on the topside of the tube.
- Then press the button  to start the measure. Everything is automatic and will end in 2/3 seconds.
- You can also change the intensity of the white leds, to change the pupil size (see next paragraph).

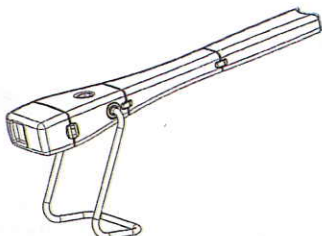

Designed and manufactured by:
Adaptica Srl - Via San Marco 9/H, 35129 - Padova (Italy)
 ph. +39 049 773 968 fax +39 049 0970901

How to change pupil size :



You have also the possibility to change the light inside the tube, in order to change the pupil size. To do that, just press the button . This way, you can see in the display the pupils of your patient in live mode. Now

you can adjust the light intensity in order to change the pupil size, by pressing the up/down direction buttons .



Once reached the desired pupil size, to start the measure, you can press the button 

How to save the Report :

1. Make your measurement.
2. Long press the print button  to save your data.
3. Short press the down button  to import the report into your tablet.
4. The report will be saved in the EXAM folder, you can reach by tapping on the "Folder"  icon of the 2WIN tablet App.
5. To exit the Exams window, just tap on the Exams blue bar at the top of the window.

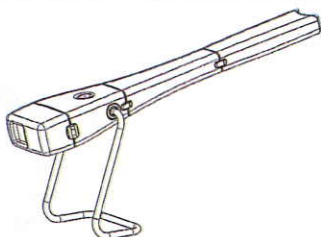

Designed and manufactured by:
Adaptica Srl - Via San Marco 9/H, 35129 - Padova (Italy)
ph. +39 049 773 968 fax +39 049 0970901

Use of 2WIN-tablet app for Remote Control of the 2WIN:

The 2WIN-tablet app lets you to control the 2WIN remotely, in general, for all the standard functions.

In particular, it is worth to mention that you can insert the patient info easily from the keyboard displayed on the tablet.

In order to do that, you just need to long press left direction (both on the tablet or in the 2WIN itself).

A keyboard will be displayed to let you to insert the patient's info (Name and Date Of Birth). To toggle from one field to the other, just press the *NEXT* button on the bottom side of the keyboard.

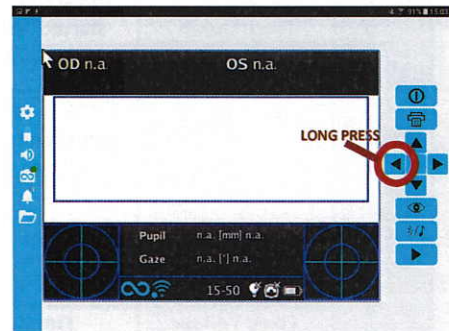

Remark: please be aware that in this version, the "attention-button(BUTTON D)" on the 2WIN  is now used to start the live mode both from the app and from the 2WIN itself. By pressing the button the first time, you start the live mode. In this modality, you can enable/disable the sound jingle, the coloured leds, and the white leds, before to start the measure. By pressing it for the second time, you will start the measure.

The aim is to let the operator to start a measure from the 2WIN unit also when the unit is inserted in the tube, and the start button is not accessible anymore (since it is in the front of the 2WIN).

To enable/disable the sound jingles (or the attention coloured lights), if needed, please consider that you can anyway just press, during the measurement, the left (or right) direction button.

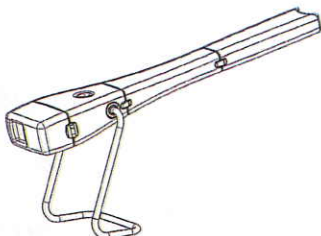
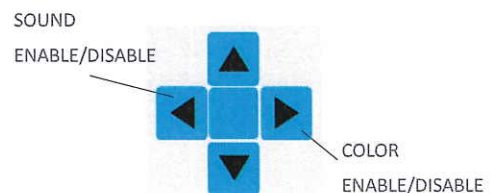

Designed and manufactured by:
Adaptica Srl - Via San Marco 9/H, 35129 - Padova (Italy)
 ph. +39 049 773 968 fax +39 049 0970901

CONTROL PANNEL FUNCTIONALITIES

		Button		
		Power	1 - Measure	2 - Network
State	Flashing Green	The system is booting up	Measure ongoing	-
	Fixed Green	The system has successfully started, there is a blinking when the activity is normal	Measure well done	2WIN correctly connected to the application
	Fixed Red	Error, please shut down the system and power it on again.	Measure error. please repeat the measurement.	WiFi NOT Connected, check 2WIN WiFi settings
	Flashing Orange	System Shutting Down	-	WiFi connection ongoing
	Fixed Orange	-	-	WiFi ON but NOT connected to the application
	Flashing Blue	-	-	Pairing ongoing
	Fixed Yellow	Firmware Updating	-	-

		Button		
		Power	1 - Measure	2 - Network
Function	Short press	System Power-UP	2 sec to start a measurement. Please notice that the measure will be automatically saved on the SD card of the 2win.	2sec (until flashing orange): WiFi reset. This operation may require up to ten seconds.
	Long press	2sec: System Power-Down More: Forced Power-OFF	-	4sec (until flashing white): Pairing Reset

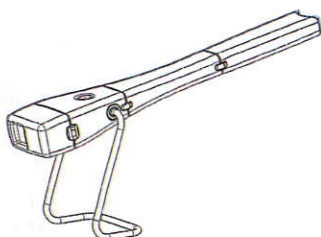

Rev. 5
14/06/2018

Designed and manufactured by:
Adaptica Srl - Via San Marco 9/H, 35129 - Padova (Italy)
 ph. +39 049 773 968 fax +39 049 0970901